

C

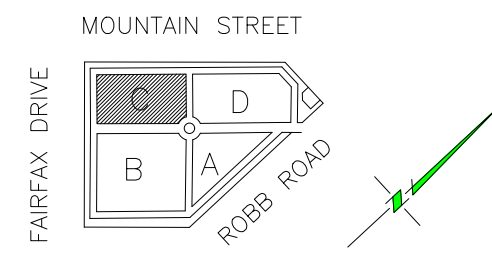

D

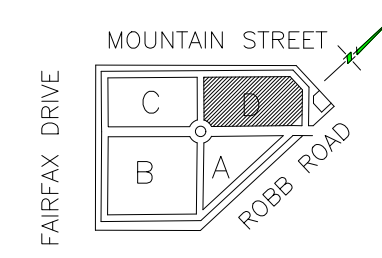

COLUMBARIUM "E"

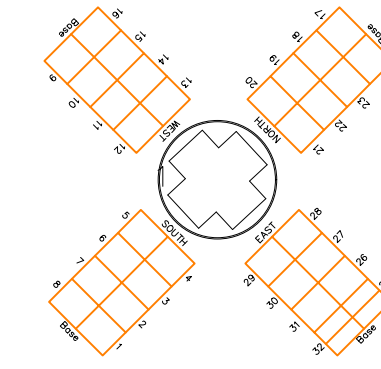

COLUMBARIUM "F"

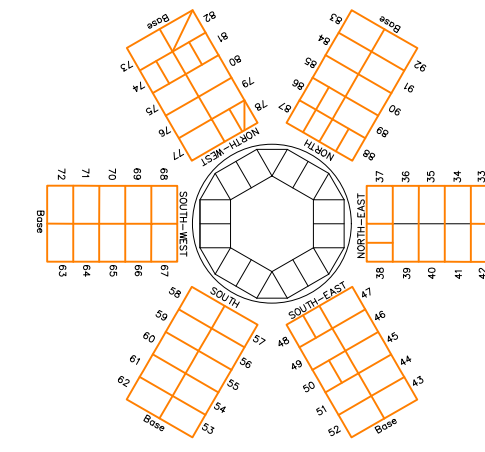

COLUMBARIUM "G"

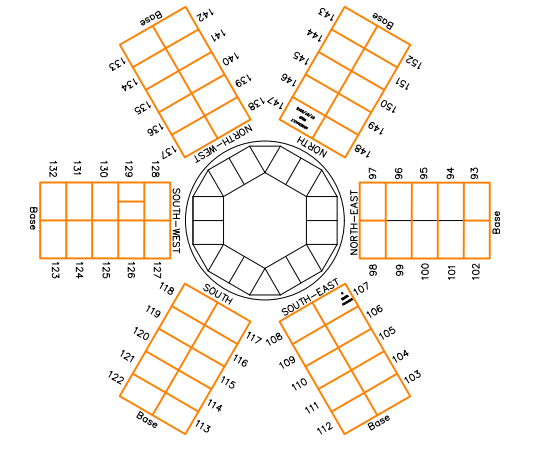

COLUMBARIUM "H"

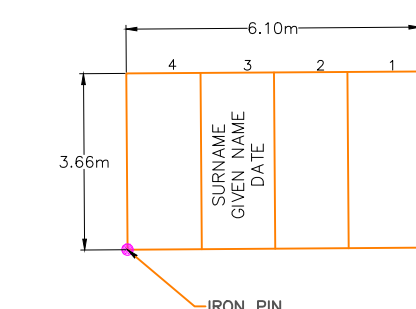
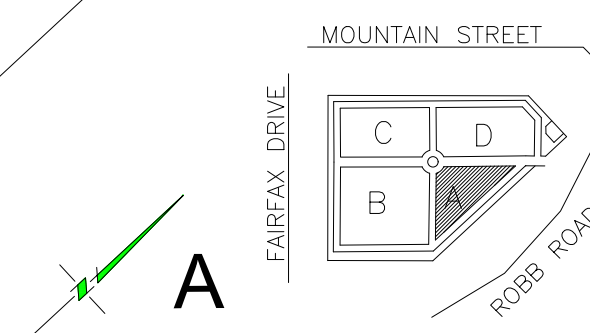
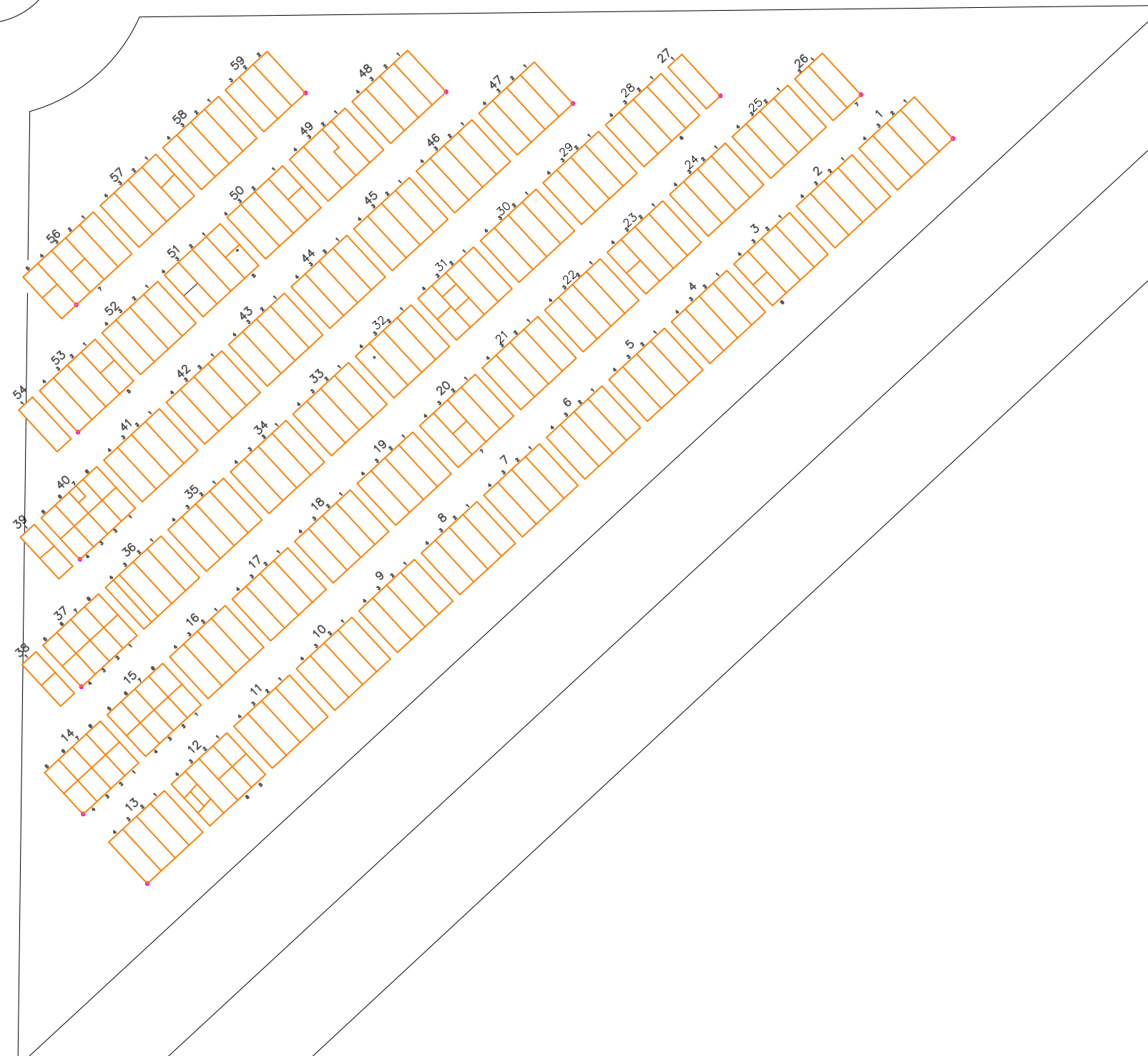
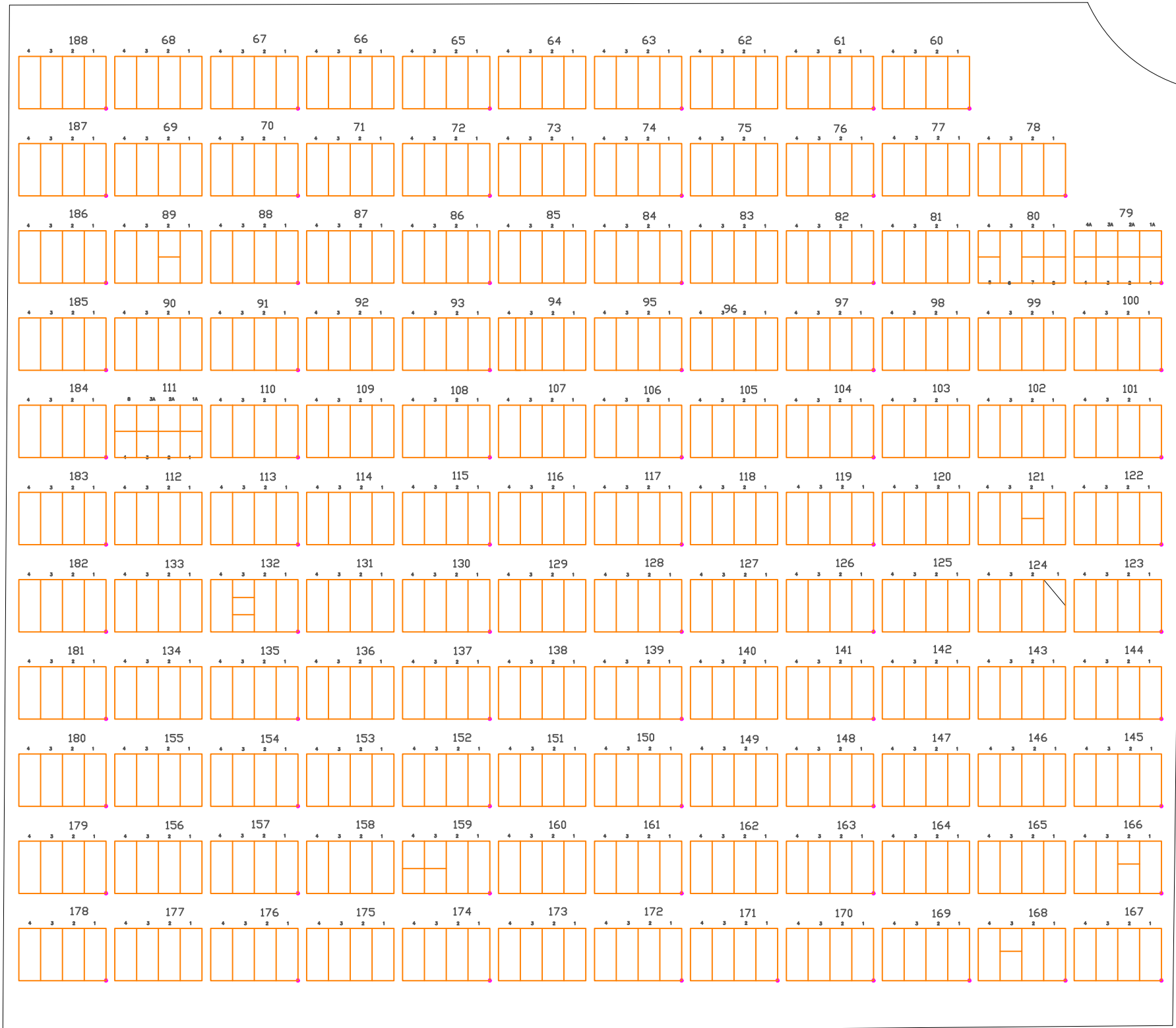
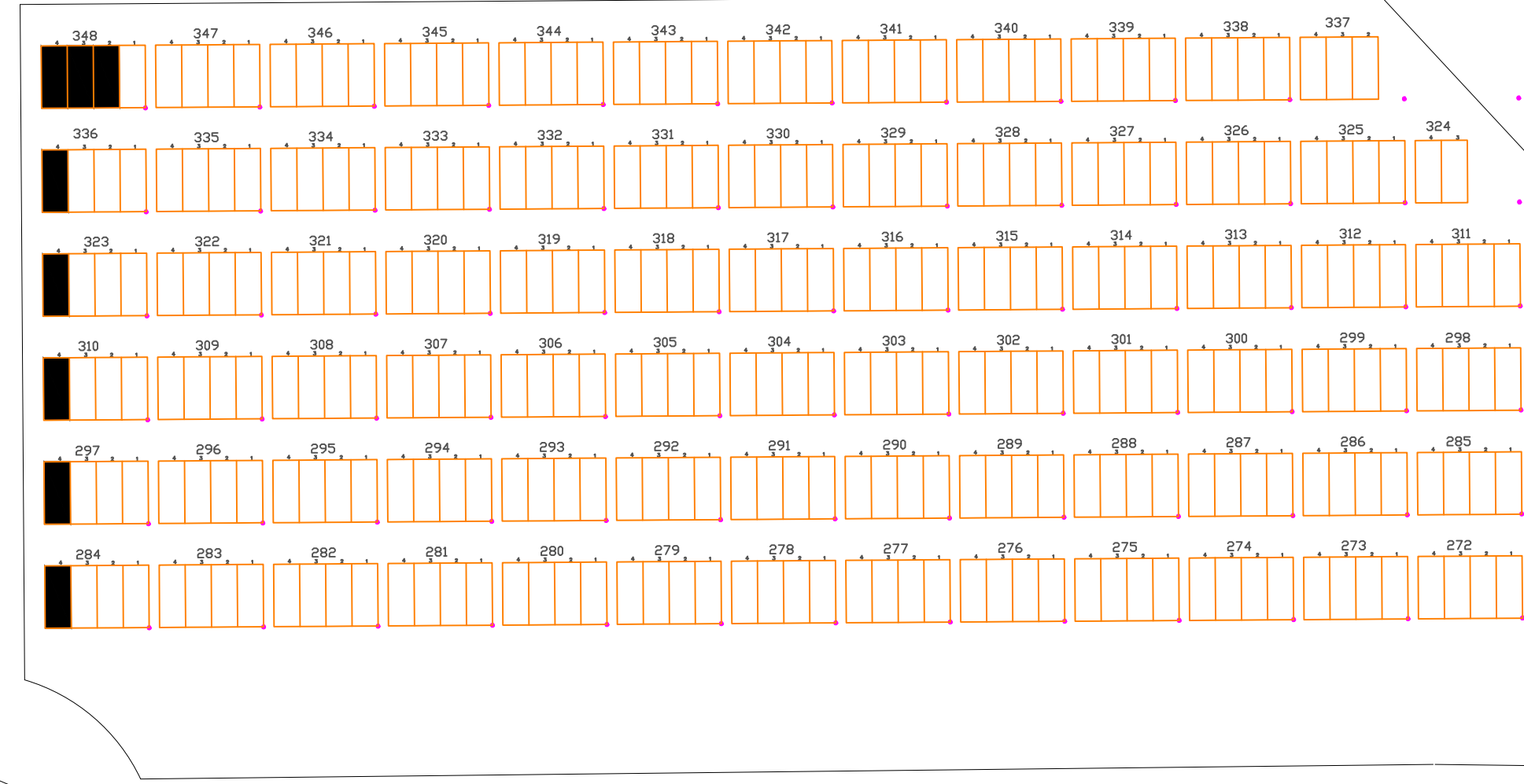
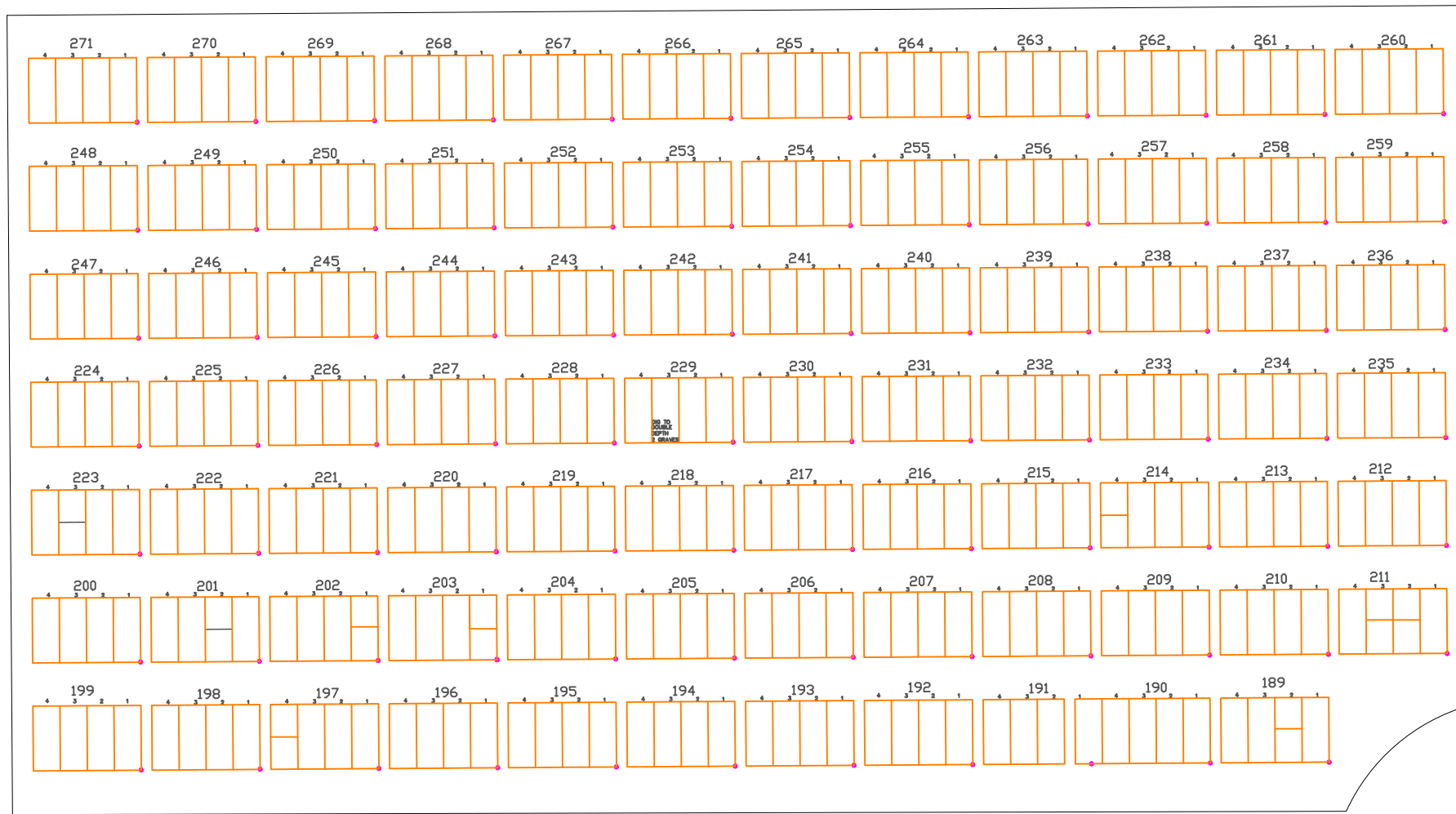
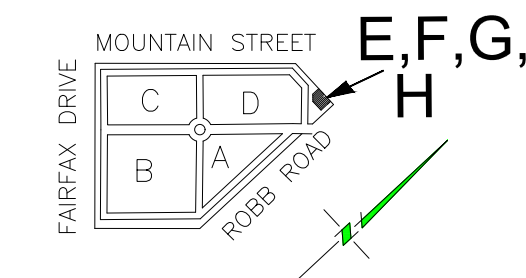
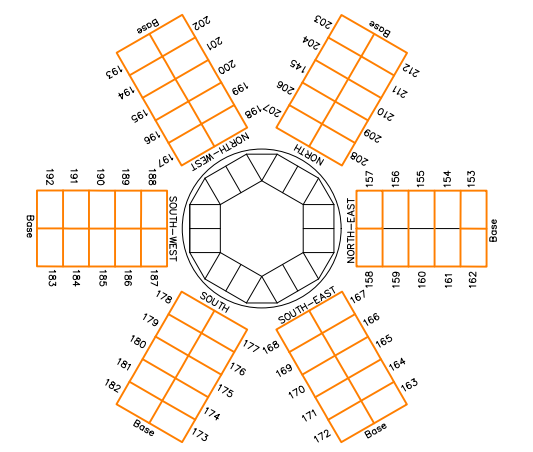

TYPICAL PLOT
BLOCK B, C, D
N.T.S.

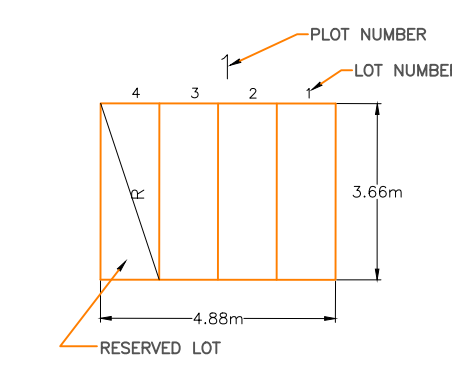

TYPICAL PLOT
BLOCK A
N.T.S.



**WOODLAWN CEMETARY
SITE PLAN**

LEGEND:
 MM/DD/YY denotes "Date of Internment"
 N.D.O.F. denotes "No Date On File"
 * denotes "Cremation"
 = denotes "Double Depth"
 R denotes "Reserved"

B

